

Sestava uchycení RD-3

Ref. C28233P00, C28233P01, C28233L10, C28233L07

Ref. arch 42659NI, 42659GSS, 42659L9010, 42659L9005



- Kompletní sada prvků
- Podélné zavěšení na lanku
- Snadné nastavení výšky zavěšení u svítidla
- Jednoduchá montáž bez sundávání koncovek
- Možnost zvolit lanko o libovolné délce

ÚČEL PRODUKTU

- k zavěšení LED svítidel

INSTALACE

- do povrchu pomocí vhodně zvolených šroubů
- do svítidla pomocí malého zámku
- lanko je zavěšené ve stropní zástrčce pomocí svorky a je možné ho nastavit u kování pomocí kleštiny

TECHNICKÝ VÝKRES

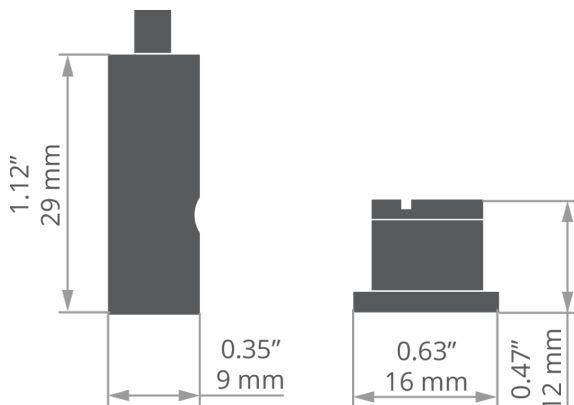

TECHNICKÁ SPECIFIKACE

| | |
|----------|-------|
| Materiál | mosaz |
| Šířka | 9 mm |
| Výška | 29 mm |
| Nosnost | 15 kg |

| | |
|---|-------------------------|
| Barva | Ref |
| <input checked="" type="checkbox"/> stříbrná lesklý | C28233P00 42659NI |
| <input checked="" type="checkbox"/> stříbrná saténový | C28233P01 42659GSS |
| <input type="checkbox"/> bílá lakovaný | C28233L10 42659L9010 |
| <input checked="" type="checkbox"/> černý lakovaný | C28233L07 42659L9005 |

Sestava uchycení RD-3

Ref. C28233P00, C28233P01, C28233L10, C28233L07

Ref. arch 42659NI, 42659GSS, 42659L9010, 42659L9005

SAMPLE PROJECTS



SOUVISEJÍCÍ PROFILY > ARCHITEKTONICKÉ



3035
A18039
Ref. arch 18039



3035-O
A08441
Ref. arch B8441

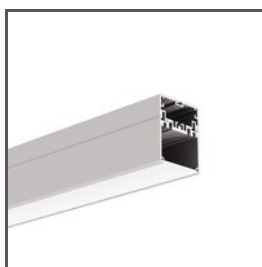

4050
A18050
Ref. arch 18050



4050-W
A18051
Ref. arch 18051



GIZA
A05556
Ref. arch B5556

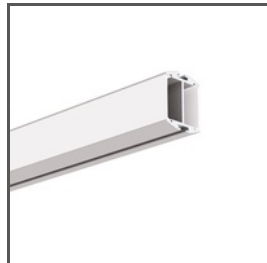

GIZA-DUO-LL
A02162
Ref. arch C2162



GIZA-LL
A00758
Ref. arch C0758

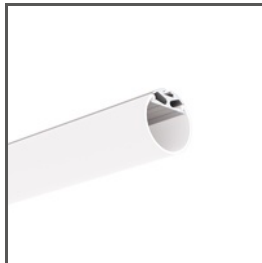

JAZ
A08547
Ref. arch B8547



LIPOD
A05554
Ref. arch B5554



OPK-4
A00370
Ref. arch C0370

SOUVISEJÍCÍ PROFILY > MINIMALISTICKÉ



PIKO-ZM
A01168
Ref. arch C1168

SOUVISEJÍCÍ PROFILY > PRO HLAVNÍ OSVĚTLENÍ

Sestava uchycení RD-3

Ref. C28233P00, C28233P01, C28233L10, C28233L07

Ref. arch 42659NI, 42659GSS, 42659L9010, 42659L9005

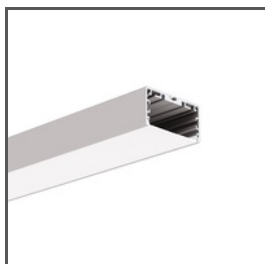

LIPOD-50
A02609
Ref. arch C2609

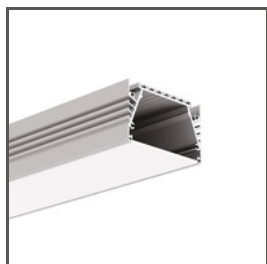

SEPOD
A06593
Ref. arch B6593

SOUVISEJÍCÍ PROFILY > UNIVERZÁLNÍ



OLEK
A08505
Ref. arch B8505



PDS-ZM-PLUS
A02056
Ref. arch C2056



PDS-ZMG
A01418
Ref. arch C1418

SOUVISEJÍCÍ SYSTÉMY > PRO OBCENÉ OSVĚTLENÍ

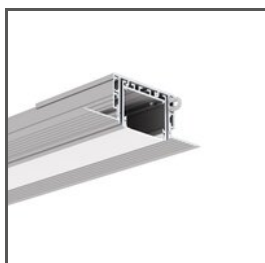

3035-KOZE
A08441+A18056
Ref. arch 18056+B8441



PK-4
A18044+A00370
Ref. arch 18044+C0370